

TM 11-5820-357-20

DEPARTMENT OF THE ARMY TECHNICAL MANUAL

ORGANIZATIONAL MAINTENANCE MANUAL

RADIO RECEIVER R-390/URR



HEADQUARTERS, DEPARTMENT OF THE ARMY
23 MARCH 1961

WARNING

DANGEROUS VOLTAGES EXIST IN THIS EQUIPMENT

Be careful when working on the 240-volt power supply and the circuits connected to it, or on the 115/230-volt ac line connections. Before connecting the receiver to an ac source, be sure that the chassis is connected to the same ground as the ac source.

DON'T TAKE CHANCES!

Technical Manual }
No. 11-5820-357-20 }

HEADQUARTERS
DEPARTMENT OF THE ARMY
WASHINGTON 25, D. C., 23 March 1961

RADIO RECEIVER R-390/URR

		Paragraph	Page
CHAPTER	1.	INTRODUCTION	
		Scope	1 2
		Forms and records	2 2
CHAPTER	2.	INSTALLATION	
		Unpacking	3 3
		Checking unpacked equipment	4 3
		Installation requirements	5 4
		External connections	6 5
		Remote control receptacle	7 5
CHAPTER	3.	MAINTENANCE INSTRUCTIONS	10
Section	I.	General	10
		Scope of second echelon maintenance	8 10
		Tools, materials, and test equipment required	9 10
		Preventive maintenance	10 10
		Lubrication of mechanical tuning system	11 11
	II.	Troubleshooting	16
		Visual inspection	12 16
		Equipment performance checklist	13 18
		Troubleshooting techniques	14 20
		Tube replacement techniques	15 22
		Removal and replacement of Power Supply PP-621/URR	16 24
		Removal and replacement of pilot lamps	17 25
CHAPTER	4.	SHIPMENT AND LIMITED STORAGE	26
		Disassembly	18 26
		Repacking for shipment or limited storage	19 26
APPENDIX		REFERENCES	27

*This manual supersedes so much of TM 11-856, 11 January 1955, as pertains to organizational maintenance.

CHAPTER 1

INTRODUCTION

1. Scope

This manual covers the installation and second echelon maintenance of Radio Receiver R-390/URR. The operating instructions for this equipment are contained in TM 11-5820-357-10.

2. Forms and Records

Forward comments concerning this manual to the Commanding Officer, U. S. Army Signal Materiel Support Agency, ATTN: SIGMS-PA2d, Fort Monmouth, N. J.

Note. For applicable forms and records, see TM 11-5820-357-10.

CHAPTER 2

INSTALLATION

3. Unpacking

a. Packaging Data (fig. 1). When packed for shipment, the components of Radio Receiver R-390/URR are placed in a carton which is packed in a wooden shipping crate (fig. 1). The wooden shipping crate is 21 inches high, 32 inches wide, and 32 inches deep. Its volume is approximately 12.4 cubic feet and the total packed weight is approximately 83 pounds.

b. Removing Contents. Perform all the steps outlined below when unpacking the equipment.

Caution: Be careful when uncrating, unpacking, and handling the equipment because it is easily damaged.

- (1) Place the crate as near the operating position as is convenient.
- (2) Cut and fold back the metal straps.
- (3) Remove nails from the top of the crate. Do not attempt to pry it off because the equipment may become damaged.
- (4) Remove the technical manuals and the paperboard carton containing the spare parts.
- (5) Slit open the fiberboard carton and fold the flaps back.
- (6) Remove the protective plywood panel.
- (7) Grasp the carrying handles of the receiver and carefully withdraw the receiver from the fiberboard padding which is between the receiver and the fiberboard carton. Place the receiver on a bench or near its final location.

4. Checking Unpacked Equipment

a. Check the contents of the cartons against the master packing slip.

b. Check the front panel of the receiver for damage to the knobs or to the glass windows of the meters and frequency indicator dial.

c. Operate the control knobs; examine them for looseness.

(1) Operate the MEGACYCLE CHANGE and KILOCYCLE CHANGE knobs throughout their ranges. Rough operations or binding may indicate a damaged tuning system.

(2) Do not operate the KILOCYCLE CHANGE knob past the point where a red+ or - sign appears on the frequency indicator.

d. Remove the top and bottom dust covers by removing the 16 screws (TM 11-5820-357-10) and lockwashers that secure the covers to the main frame. Replace the screws and lockwashers that hold the dust covers in their positions so that they are available when the dust covers are reinstalled.

e. Inspect the subchassis on the upper and lower decks of the receiver for loose tube shields and broken tubes.

f. If the receiver is to be used in a fixed installation, remove the shields from all tubes (fig. 8 and 9), except V201 through V206, V505, and V701.

g. Unless extremely dusty conditions are expected, do not replace the dust covers.

h. Do not replace the dust covers if the receiver is to be installed in Cabinet, Electrical Equipment CY-979/URR or CY-917/URR. Securely wrap the tube shields and the dust covers. Mark the nomenclature and the serial number of the receiver from which they were removed on the cover of the package. Store them for future use. Reinstall the tube shields and dust covers when the receivers are stored or shipped.

i. See that all connectors are seated firmly and are in their respective sockets. Loose or improperly seated connectors are a common cause of faulty operation of radio equipment.

j. Remove the three fuses from the rear panel (TM 11-5820-357-10). Check to see that they are of the proper rating. Make sure that the fuses are firmly seated after replacing them.

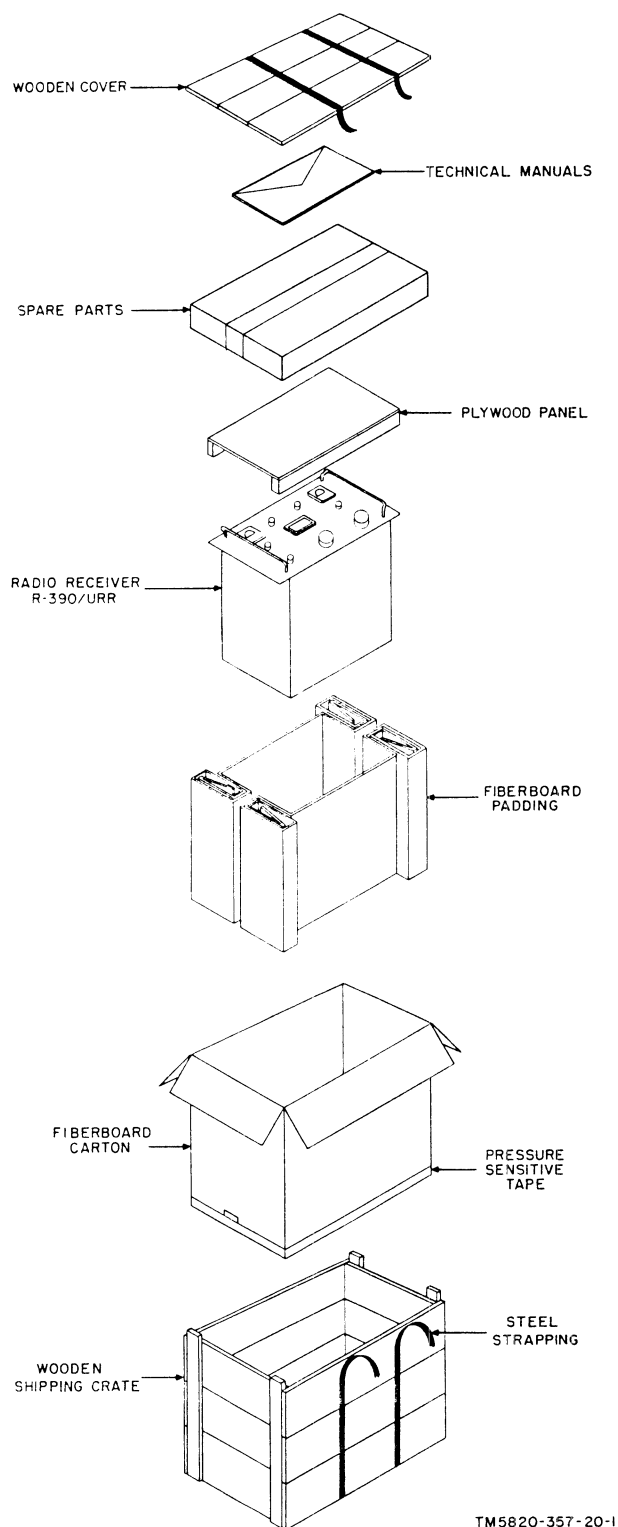

Figure 1. Unpacking.

k. Inspect for bent or broken connectors and terminals on the rear panel. See that

the special tools are placed in their holders (TM 11-5820-357-10).

l. Remove the small cover (TM 11-5820-357-10) at the lower right-hand corner of the rear panel. See that the spare fuses are of the proper ratings and are in place.

m. Check the contents of the box that contains the running spares for damaged parts.

n. Perform the installation and connection procedures given in paragraphs 5 and 6.

Caution: To avoid serious damage to the receiver, do not use any fuse other than the value specified.

5. Installation Requirements

If the receiver is used as a part of a system, refer to the technical manual for that system. Instructions for installing the receiver for fixed and mobile use are listed in a through d below.

Note. The receiver is frequently used with rhombic, doublet, or double-doublet receiving-type antennas. For information on the rhombic and doublet antennas, refer to TM 11-666. For information on the double-doublet antenna, refer to TM 11-2629.

a. *Fixed tabletop Installation.* When housed in cabinet CY-917/URR or a similar well-ventilated case for fixed operation, the receiver can be placed on any sturdy bench, table, or desk.

b. *Fixed Cabinet Installation.* To install the receiver in a standard cabinet, such as Cabinet, Electrical Equipment CY-1119/U, remove the top and bottom dust covers to increase ventilation. Remove one of the blank panels from the cabinet and install the receiver. Secure the front panel to the cabinet with the bolts removed from the blank panel. Insert them in the elongated holes along the vertical edges of the receiver front panel.

c. *Mobile, Tabletop Installation.* When the receiver is housed in Cabinet, Electrical Equipment CY-979/URR for mobile operation, the cabinet must be securely bolted to a table or bench. Allow enough room for ventilation, access to the connections on the back panel, and withdrawal of

the receiver from the cabinet for servicing. Adequate lighting facilities must be provided to permit reading the control names and positions during day and night operation.

d. Mobile, Cabinet, or Rack Installation. When the receiver is installed in Cabinet, Electrical Equipment CY-1216/U for mobile operation, the cabinet must be securely bolted to the vehicle body. Allow enough room for access to backpanel connections and for the withdrawal of the receiver for servicing. Provision for lighting must be made to permit reading control names and positions during day and night operation.

Caution: When the receiver is installed in any cabinet other than described above, adequate ventilation must be provided. For

mobile applications of the receiver in cabinets other than Cabinets, Electrical Equipment CY-979/URR and CY-1216/U, support must be provided at the rear of the receiver, so that the front panel does not carry the entire weight of the receiver.

6. External Connections

Use the step-by-step procedure shown in figure 2 to make the external connections to the rear panel (TM 11-5820-357-10) of the receiver.

7. Remote Control Receptacle

Several terminals on terminal boards TB101 and TB102 are connected in parallel with REMOTE CONTROL J105 receptacle. This receptacle is not ordinarily used.

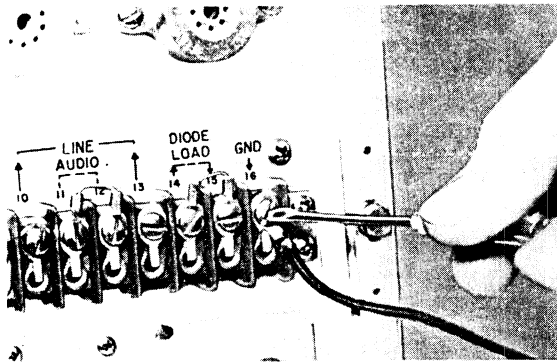

1 Connect GND terminal 16 to the same ground used with associated equipment.

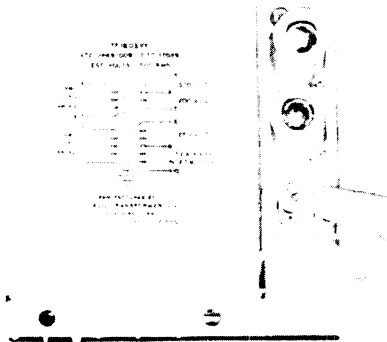

2 Determine whether the power source is 115 vac or 230 vac, then check to see that 115/230 volt switch S801 on Power Supply PP-621/URR is in the proper position for operation of the receiver from the available power source.

Caution: If the receiver is to be operated from a 230 volt ac source, change the fuse marked AC3A from a 3 ampere, 125 volt type MS FO2D3RB to a 1½ ampere, 250 volt type MS FO2G3ROOA.

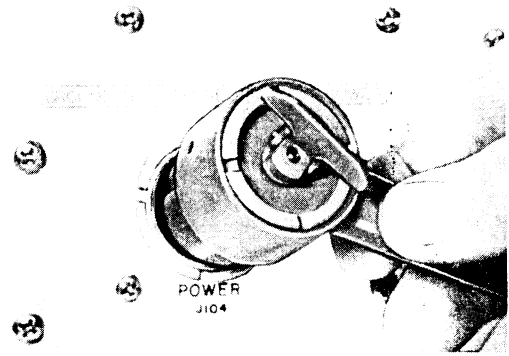

3 Connect Power Cable Assembly CX-1358/U between the power source and the POWER receptacle J104.



4 To connect the receiver to a 50 to 200 ohm balanced antenna, such as a balanced doublet, to the BALANCED ANTENNA Connector, use Radio Frequency Cable RG-22/U with Connector Plug UG-421/U or use Radio Frequency Cable RG-86/U with Connector Plug UG-969/U.

TM5820-357-20-2 ①

Figure 2(1). Connecting procedures (part 1 of 4).

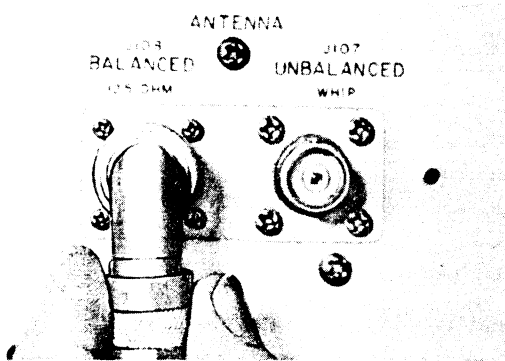

5 To adapt unbalanced coaxial lead-in cable to the BALANCED ANTENNA CONNECTOR, use Adapter Connector UG-971/U when lead-in is terminated in Connector Plug UG-573/U.

Note: Use Connector Plug UG-970/U when coaxial cable is terminated in Connector Plug PL-259.

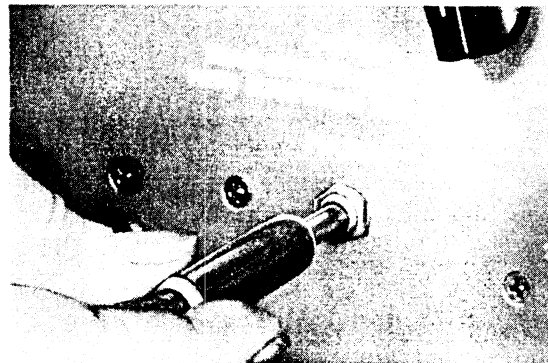

7 Plug the 600 ohm headset into the PHONES jack. If the headset is to be connected to the rear panel terminal board perform step 8.

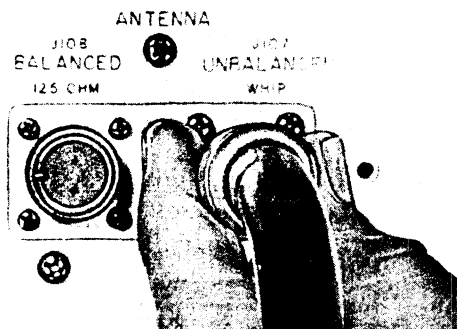

6 Use Connector Plug UG-573/U to connect the unbalanced ANTENNA CONNECTOR to a whip antenna or to a random-length single-wire antenna. The whip lead-in should be as short a length as possible of Radio Frequency Cable RG-8/U or RG-11/U.

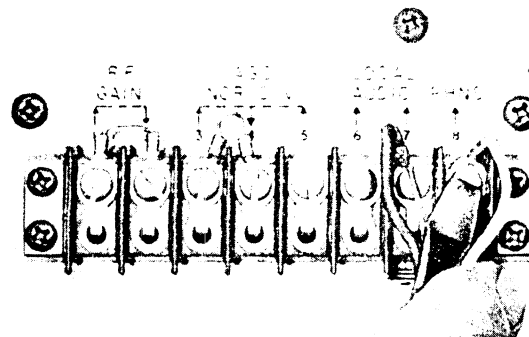

8 Connect the headset to the PHNS terminal 8 and terminal 7 (ground).

TM5820-357-20-2 ©

Figure 2(2). Connecting procedure (part 2 of 4).

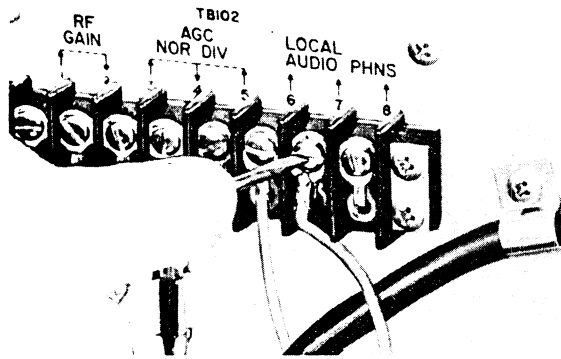

9 Connect the loudspeaker (if used) to LOCAL AUDIO terminals 6 and 7.

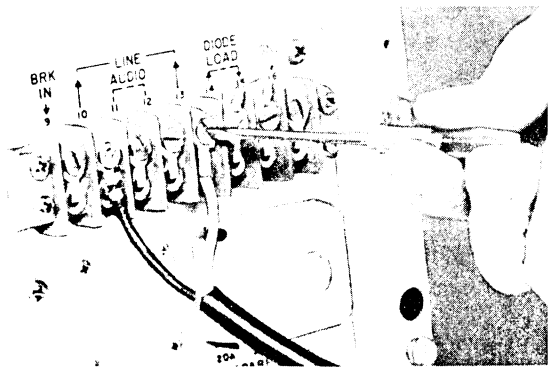

10 For balanced line audio output operation, connect the balanced line to LINE AUDIO terminals 10 and 13. If a balancing bridge is to be used for remote applications perform steps 11 and 12.



11 Remove the jumper from terminals 11 and 12.

12 Connect the balancing bridge between terminals 11 and 12, (see step 11).

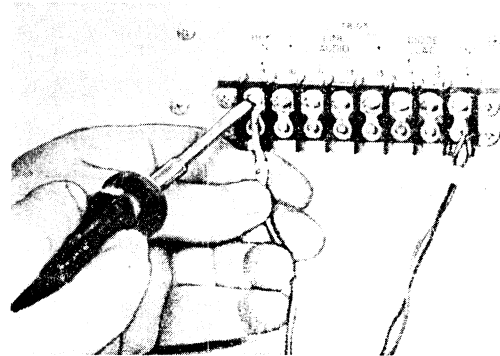

13 If a transmitter is being used with the receiver in break-in operation, connect the control lines from the transmitter to BRK-IN terminal 9 and GND terminal 16.

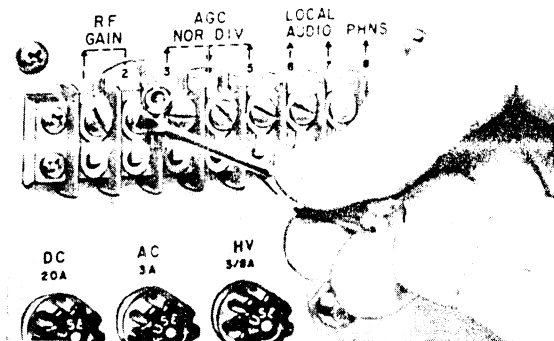

14 For external rf gain control, remove the jumper between RF GAIN terminals 1 and 2 and perform step 15.

15 Connect an external 5,000-ohm potentiometer to RF GAIN terminal 1 and to terminal 7 ground, (see step 14).

TM5820-357-20-2 ③

Figure 2(3). Connecting procedures (part 3 of 4).

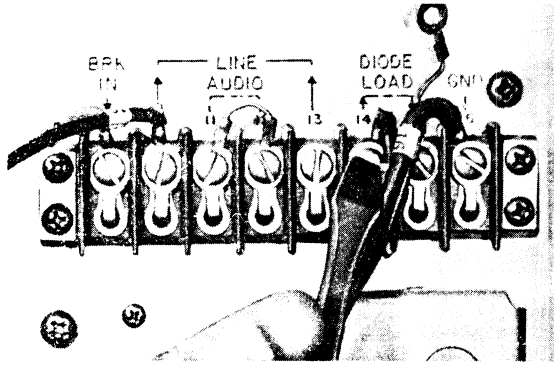

16 To use an external diode load, remove jumper from DIODE LOAD terminals 14 and 15 and perform step 17.

17 Connect the lines from the external diode load to terminals 14 and 15. (see step 16).

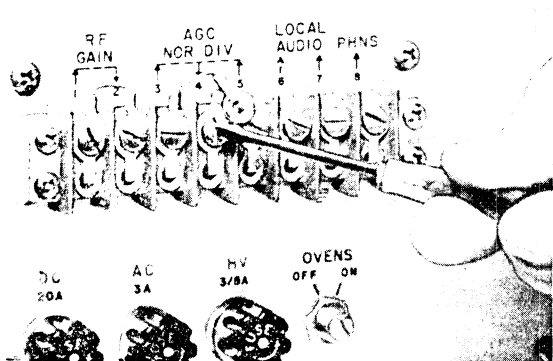

18 For external agc, remove the jumper from AGC NOR terminals 3 and 4 and perform step 19.

19 Connect the negative terminal of the external agc source to terminal 4 and the positive terminal of the agc source to terminal 7 (ground) (see step 18).

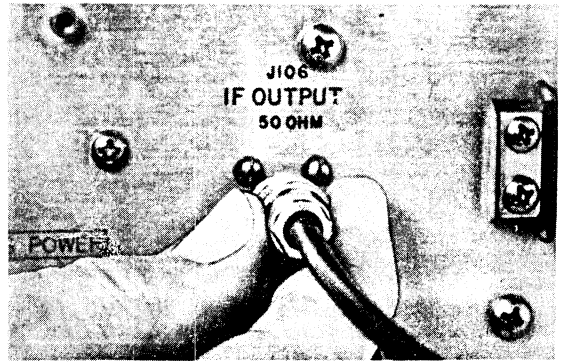

20 Connect coaxial transmission cable terminated in Radio Frequency Plug UG-88/U to IF OUTPUT receptacle J106 when it is necessary to use the IF output of the receiver.

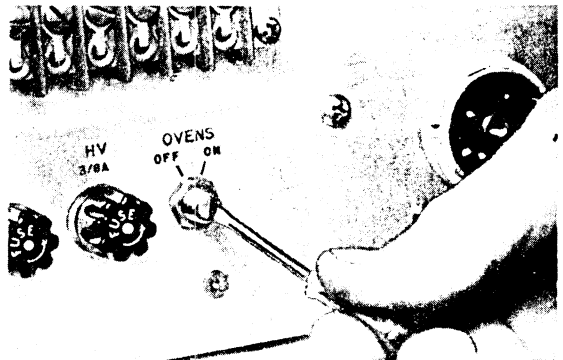

21 If wide variations in temperature are likely to be encountered, turn the OVENS heater switch to ON.

TM5820-357-20-2 ④

Figure 2(4). Connecting procedures (part 4 of 4).

CHAPTER 3

MAINTENANCE INSTRUCTIONS

Section I. GENERAL

8. Scope of Second Echelon Maintenance

Second echelon maintenance consists of the following:

- a. Preventive maintenance (para 10).
- b. Lubrication (para 11).
- c. Visual inspection (para 12).
- d. Replacement of crystals (para 14).
- e. Replacement of tubes (para 15).
- f. Replacement of defective fuse (para 16).
- g. Replacement of power supply PP-621/URR (para 16).
- h. Replacement of pilot lamps (para 17).

9. Materials, Tools, and Test Equipment Required

The materials, tools, and test equipment required for second echelon maintenance are listed below.

a. *Tools.* Tool Equipment TE-41 is required in addition to the following special tools (mounted on the back panel) supplied with the equipment.

- (1) *Phillips screwdriver.* The Phillips screwdriver is used to remove the screws that fasten the dust covers, the front panel, the removable sub-chassis, and the terminal boards.
- (2) *Fluted socket wrench.* The No. 8 socket wrench is used to remove the front panel bar knobs and the MEGACYCLE CHANGE and KILOCYCLE CHANGE knobs.
- (3) *Tube pullers, seven- and nine-pin.* The seven- and nine-pin tube pullers are used to facilitate the removal of the miniature tubes.

(4) *Tube pin straighteners.* The seven- and nine-pin tube pin straighteners are used to straighten the pins on tubes before replacement in the receiver.

b. Materials.

Cheesecloth, bleached, lint-free.
Lubricating oil, general purpose (OGP), MIL-L-7870.
Cleaning Compound (Federal stock No. 7930-395-9542).
Grease, aircraft and instrument (GL).

c. Test Equipment.

Nomenclature	Common name	Technical manual
Test Set, Electron Tube TV-7/U.	Tube tester	TM 11-6625-274-12
Multimeter AN/URM-105	Multimeter	TM 11-6625-203-12

10. Preventive Maintenance

a. *DA Form 11-238.* DA Form 11-238 (fig. 3 and 4) is a preventive maintenance checklist to be used by organizational maintenance personnel. Items not applicable to the equipment are lined out in the figures. References in the ITEM block in the figures are to paragraphs that contain additional maintenance information pertinent to the particular item. Additional preventive maintenance information concerning DA Form 11-238 will be found in the preventive maintenance portion of TM 11-5820-357-10.

b. *Items.* The information in this subparagraph supplements DA Form 11-238. The item numbers correspond to the ITEM numbers on the form.

Item	Maintenance procedures
15	Remove top and bottom dust covers (fig. 5 and 6) where necessary. Inspect all tubes for proper seating, without removing them. Figures 8 and 9 show the locations of all tubes.
19	Use a clean, dry, lint-free cloth for cleaning. Moisten the cloth with cleaning compound if necessary. After cleaning, wipe parts dry with a dry, lint-free cloth.

Warning: Cleaning compound is flammable and its fumes are toxic. Do not use near a flame; provide adequate ventilation.

11. Lubrication of Mechanical Tuning System

a. General. The only parts of the receiver that require lubrication (fig. 7) are the mechanical tuning system (which includes the gear train, slug racks, and the cam rack) and the BFO PITCH control shaft bearing. The receiver is lubricated at the factory and should be lubricated thereafter, once every 6 months, under normal operating conditions. If inspection indicates the need, or if abnormal conditions or activities are encountered, shorten the interval between lubrications. Overlubrication causes more harm than no lubrication. Check the condition of the mechanical tuning system whenever the receiver is withdrawn from the case or rack for servicing. Manually rotate the MEGACYCLE CHANGE and KILOCYCLE CHANGE controls throughout their ranges, and note ease of operation. Check for lack of lubrication on gears, edges of cams, cam rollers, guide slots, and bearing; inspect for gritty grease and oil. Operate the BFO PITCH control; if operation is rough or uneven, check the lubrication of the control shaft bearing.

Caution: Do not attempt to lubricate the sealed variable-frequency oscillator (vfo), regardless of possible noisy operation of the unit during tuning. Unstable operation of the oscillator may result.

b. Cleaning Before Lubrication. Remove the dust covers from the rf subchassis. Use a thin, long-handled brush with medium bristles, dipped in cleaning compound. Remove dirt, oil, and grease from the gears, cams, guide slots, and bearings. To reach all the gear teeth while cleaning, rotate the MEGACYCLE CHANGE and KILOCYCLE CHANGE knobs. After dipping the brush in cleaning compound, remove the excess to prevent compound from dripping on the connecting cables, wiring, or other electrical parts. Use a clean, lint-free cloth moistened with cleaning compound to remove grease from the metal castings and chassis. Thoroughly wipe all parts with a clean, dry, lint-free cloth before proceeding with cleaning.

c. Detailed Lubrication Instructions. Lubricate the gear train, slug racks, and cam racks as indicated in figure 7. To apply oil to the bearings, dip a length of wire into the oil (OGP) to collect a small drop at the end, and transfer the oil to the bearings by touching the end of the wire to the edge of the bearings. Avoid using excessive amounts of oil (OGP). A standard grease gun and a thin, long-handled brush should be used for applying grease (GL) to gear teeth, edges of cams, and tuning rack guide slots. Rotate the MEGACYCLE CHANGE and KILOCYCLE CHANGE controls as necessary to expose the gear teeth.

ADDITIONAL ITEMS FOR 2D AND 3D ECHELON INSPECTIONS		CONDITION
26. IMPROPER ANTENNA FOR ECHELON LOOSE FIT DAMAGED INSULATORS AND REFLECTORS		
27. CHECK FOR NORMAL OPERATION.		✓
28. BEFORE SHUTTING OR REPAIRING REMOVE BATTERIES		

IF DEFICIENCIES NOTED ARE NOT CORRECTED DURING THE INSPECTION, INDICATE ACTION TAKEN FOR CORRECTION.

MAINTENANCE CHECK LIST FOR SIGNAL EQUIPMENT
 SOUND EQUIPMENT, RADIO, DIRECTION FINDING
 RADAR, CARRIER, RADIOSONDE AND TELEVISION
 (AR 750-625)

EQUIPMENT NOMENCLATURE
RADIO RECEIVER R-390/URR

EQUIPMENT SERIAL NUMBER
696

INSTRUCTIONS

This form may be used for a period of one month by using the correct dates and weeks of the month. It is to be used as a Preventive Maintenance check list for Signal equipment in actual use, or for a check on equipment prior to issue.

- For detailed Preventive Maintenance instructions see:
 - The Technical Manual (in TM 11 series) for the equipment. (See DA Pamphlet Number 310-4)
 - The Supply Bulletin (SB 11-100 series) for the equipment. (See DA Pamphlet Number 310-4)
 - The Department of the Army Lubrication Order. (See DA Pamphlet Number 310-4)
- The following action will be taken by either the Communications Officer/Chief for 1st echelon, or the Inspector for higher echelon:
 - Enter Equipment Nomenclature and Serial Number.
 - Strike out items that do not apply to the equipment.
- Operator/Inspector will enter in the columns entitled **CONDITION**, on the proper line, a notation regarding the condition, using symbols specified under **LEGEND**.
- After operator completes each daily inspection he will initial over the appropriate dates under "Daily Condition for Month", then return form to his supervisor.

TYPE OF INSPECTION			DATE	SIGNATURE
OPER-ATOR	2/3 ECHELON			
✓			10 JAN	Cpl. M. G. Lashan
✓			17 JAN	Cpl. M. G. Lashan
	✓		18 JAN	M/Sgt D. McCracken

DA FORM 11-238
 1 MAY 57

REPLACES DA FORMS 11-238, 1 NOV 55; 11-239, 11-244, 11-245, 11-248, 11-249, 11-250, AND 11-251; WHICH ARE OBSOLETE.

Figure 3. DA Form 11-238, pages 2 and 3.

LEGEND for marking conditions: Satisfactory, Y. Adjustment, Repair or Replacement required, X. Defect corrected, (X).		DAILY CONDITION FOR MONTH OF																2D 3D ECH- ELON
		1	2	3	4	5	6	7	8	9	10	11	12	13	14	15	16	
NO.	DAILY ITEM																	CONDITION
		WEEKLY																
		CONDITION EACH WEEK				ADDITIONAL ITEMS FOR 2D AND 3D ECHELON INSPECTIONS												CONDITION
		1ST	2D	3D	4TH	5TH	6TH	7TH	8TH	9TH	10TH	11TH	12TH	13TH	14TH	15TH	16TH	
1.	COMPLETENESS AND GENERAL CONDITION OF EQUIPMENT. (Communication receiver, teletype, radio, cables, microphone, tubes, spare parts, technical manuals).	✓	✓	✓	✓	✓	✓	✓	✓	✓	✓	✓	✓	✓	✓	✓	✓	LM
2.	CLEAN DIRT AND MOISTURE FROM ANTENNA, HEAD- PHONE, HEADSETS, JACKS, PLUGS, COMPONENT PANELS.	✓	✓	✓	✓	✓	✓	✓	✓	✓	✓	✓	✓	✓	✓	✓	✓	LM
3.	INSPECT CONTROLS FOR NORMAL OPERATION. TAP CONTROLS LIGHTLY FOR EVIDENCE OF CUT-OUT FROM LOOSE CONTACTS.	✓	✓	✓	✓	✓	✓	✓	✓	✓	✓	✓	✓	✓	✓	✓	✓	LM
4.	CHECK FOR NORMAL OPERATION OF EQUIPMENT. BE ALERT FOR UNUSUAL OPERATION OR CONDITION.	✓	✓	✓	✓	✓	✓	✓	✓	✓	✓	✓	✓	✓	✓	✓	✓	LM
5.	CLEAN AND TIGHTEN EXTERIORS OF CASES, BASES, MOUNTS, ATTACHMENTS.	✓	✓	✓	✓	✓	✓	✓	✓	✓	✓	✓	✓	✓	✓	✓	✓	LM
6.	INSPECT CASES, MOUNTS, ATTACHMENTS AND EXPOSED METAL SURFACES FOR RUST, CORROSION.	✓	✓	✓	✓	✓	✓	✓	✓	✓	✓	✓	✓	✓	✓	✓	✓	LM
7.	INSPECT CORDS, CABLE, WIRE, CONNECTIONS FOR CUTS, KINKS, BREAKS, FRAYING, UNDUE STRAIN.	✓	✓	✓	✓	✓	✓	✓	✓	✓	✓	✓	✓	✓	✓	✓	✓	LM
8.	CHECK TERMINALS AND CONNECTIONS FOR CORROSION.	✓	✓	✓	✓	✓	✓	✓	✓	✓	✓	✓	✓	✓	✓	✓	✓	LM
9.	INSPECT CABLES AND LEADERS FOR CORROSION AND FRAYING.	✓	✓	✓	✓	✓	✓	✓	✓	✓	✓	✓	✓	✓	✓	✓	✓	LM
10.	INSPECT ACCESSIBLE ITEMS FOR LOOSENESS: SWITCHES, KNOBS, JACKS, CONNECTORS, RELAYS, TRANSFORMERS, MOTORS, PILOT LIGHTS, BATTERIES, ETC.	✓	✓	✓	✓	✓	✓	✓	✓	✓	✓	✓	✓	✓	✓	✓	✓	LM
11.	CLEAN AND/OR INSPECT AIR FILTERS, GRASS NAME PLATES, DIAL AND METER WINDOWS.	✓	✓	✓	✓	✓	✓	✓	✓	✓	✓	✓	✓	✓	✓	✓	✓	LM
12.	INSPECT STORAGE BATTERIES FOR SHORT-LEADS, TERMINALS, SPRINGS, DAMAGED BATTERIES, SUBJECT TO BATTERIES FOR LEAKAGE.	✓	✓	✓	✓	✓	✓	✓	✓	✓	✓	✓	✓	✓	✓	✓	✓	LM
ADDITIONAL ITEMS FOR 2D AND 3D ECHELON INSPECTIONS																		CONDITION
18. INSPECT SEATING OF READILY ACCESSIBLE PLUCK-OUT ITEMS: TUBES, LAMPS, FUSES, CRYSTALS, CONNECTORS, ATTACHMENTS, PLUGS, JACKS.																		⊗
19. INSPECT RELAYS AND CONTACTS FOR LOOSE MOUNTINGS, BAD CONTACTS, MIS-ALIGNMENT OF CONTACTS AND SPRINGS, PROPER SPRING TENSION.																		✓
17. INSPECT TERMINALS AND CONNECTIONS FOR CORROSION.																		✓
18. INSPECT RESISTORS, CONDENSERS AND INSULATORS FOR CRACKS, CHIPPING, BLISTERING, MOISTURE, DISCOLORATION.																		✓
19. CLEAN AND TIGHTEN SWITCHES, TERMINAL BLOCKS, RELAYS, RELAY CASES AND INTERIORS OF CHASSIS AND CABINETS NOT READILY ACCESSIBLE.																		✓
20. INSPECT TERMINAL BLOCKS FOR LOOSE CONNECTIONS, CRACKS AND BREAKS.																		✓
21. INSPECT TERMINALS OF LINES, PHONES, CABLES AND RESISTORS FOR CORROSION, LOOSE CONTACTS.																		✓
22. INSPECT TRANSFORMERS, CHOKES, POTENTIOMETERS AND RESISTORS FOR OVERHEATING AND SHORTEDS.																		✓
23. INSPECT GENERATORS AND INDUCTION MOTORS FOR CORROSION, OVERHEATING, PROPER TENSION, MISSING AND FITTING OF COMMUTATOR.																		✓
24. INSPECT BATTERIES AND FUSES FOR CORROSION.																		✓
25. INSPECT WATERPROOF SHEETS FOR CORROSION, MISSING OR DAMAGED.																		✓

CONTINUED ON PAGE 4

Figure 4. DA Form 11-238, pages 1 and 4.

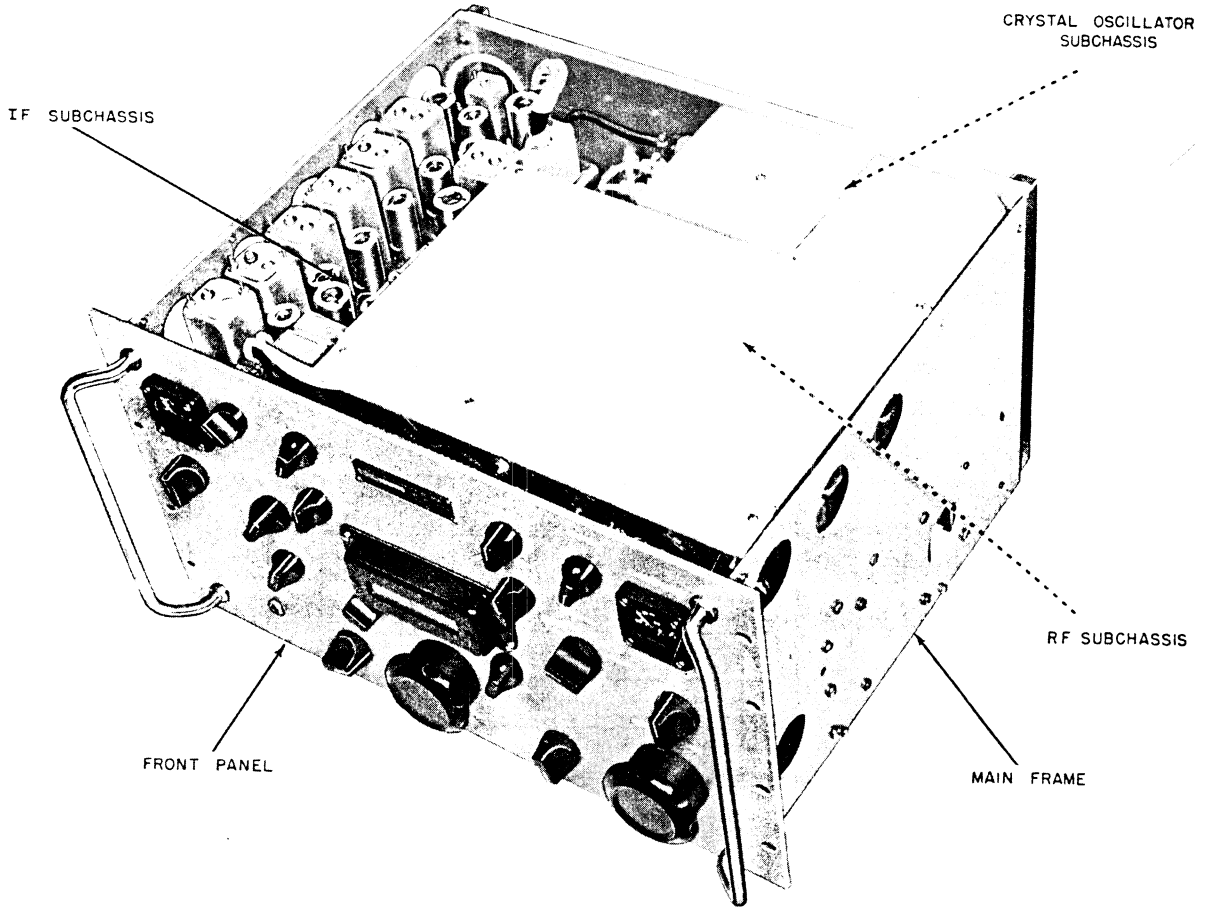

TM5820-357-20-13

Figure 5. Radio receiver, front view, dust cover removed.

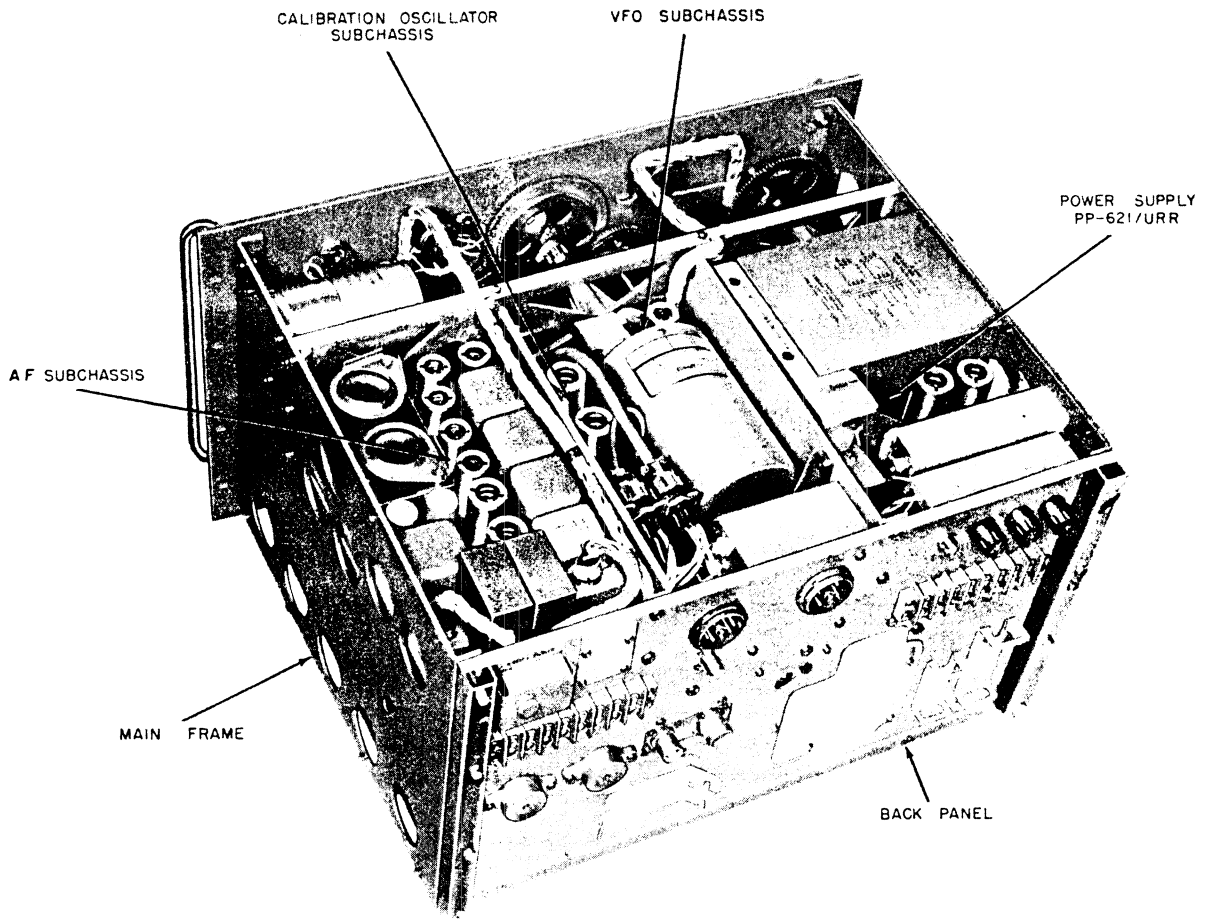

TM5820-357-20-14

Figure 6. Radio receiver, rear view, dust cover removed.

LUBRICANTS	INTERVAL
OGP-MIL-L-7870-LUBRICATING OIL GENERAL PURPOSE	6M-6 MONTHS
GL-MIL-G-3278-GREASE, AIRCRAFT AND INSTRUMENTS	

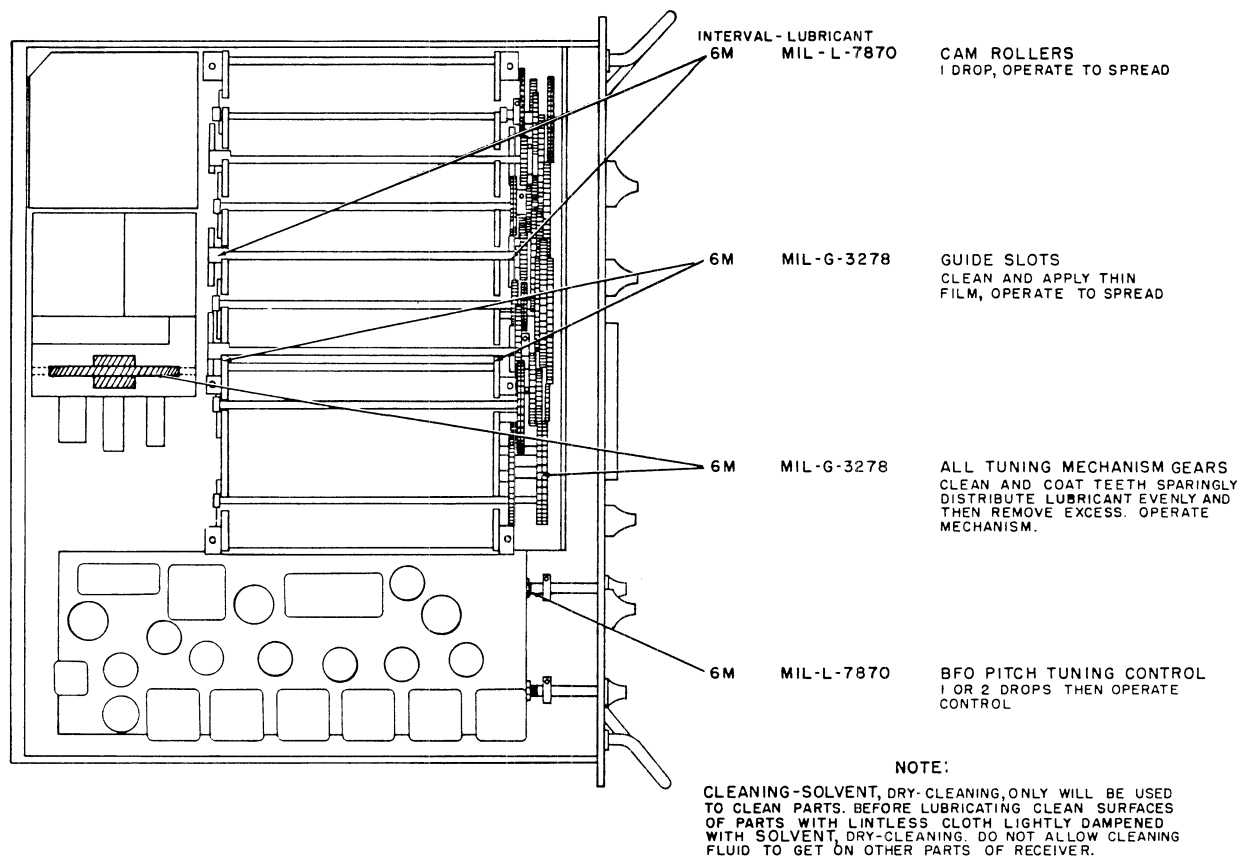

Figure 7. Lubrication.

Section II. TROUBLESHOOTING

12. Visual Inspection

a. *General.* Before operating the equipment, inspect it. This will save repair time and may also avoid further damage to the radio set. Inspect for the following:

- (1) Improperly connected, worn, or broken power cable.
- (2) Improperly connected, worn, or broken loudspeaker or headset cord.
- (3) Improperly seated or transposed subchassis connectors.

(4) Loose or broken connections on terminal boards on the rear of the receiver.

(5) Burned-out fuse.

(6) Unlighted or broken tubes.

b. *Detailed Tube Replacement Information.* Visually inspect the tubes for burned-out filaments. This is indicated when one or more tubes are not lighted. This condition can be caused by one filament burning out in a circuit that has several filaments in series.

- (1) All filaments, except the four connected directly across the 25.2-volt filament supply, are connected in series circuits which include two, three, or four filaments.
- (2) In a series circuit, an open filament in one stage will cause another stage to appear defective. Tubes V605, V606, V801, and V802, oven heaters HR401, HR701, and HR901, and indicating lamps I101 and I102 are connected directly across the 25.2-volt filament supply. Cold-cathode, gas-filled tubes V608 and V609, also known as glow-discharge voltage regulators, do not require heated filaments.
- (3) Figures 8 and 9 show the locations of all tubes in Radio Receiver

R390/URR. As an aid in locating trouble caused by an open filament circuit, the referenced designations of the tubes are listed in the chart below.

Series filament circuits
V202, V203, V204, and V205
V401, V402, and V201
V501, V502, V503, and V504
V505, V506, and V511
V507, and V510
RT512, V508 and V701
V601 and V602
V603, V604, V607 and V509
V901 and V902

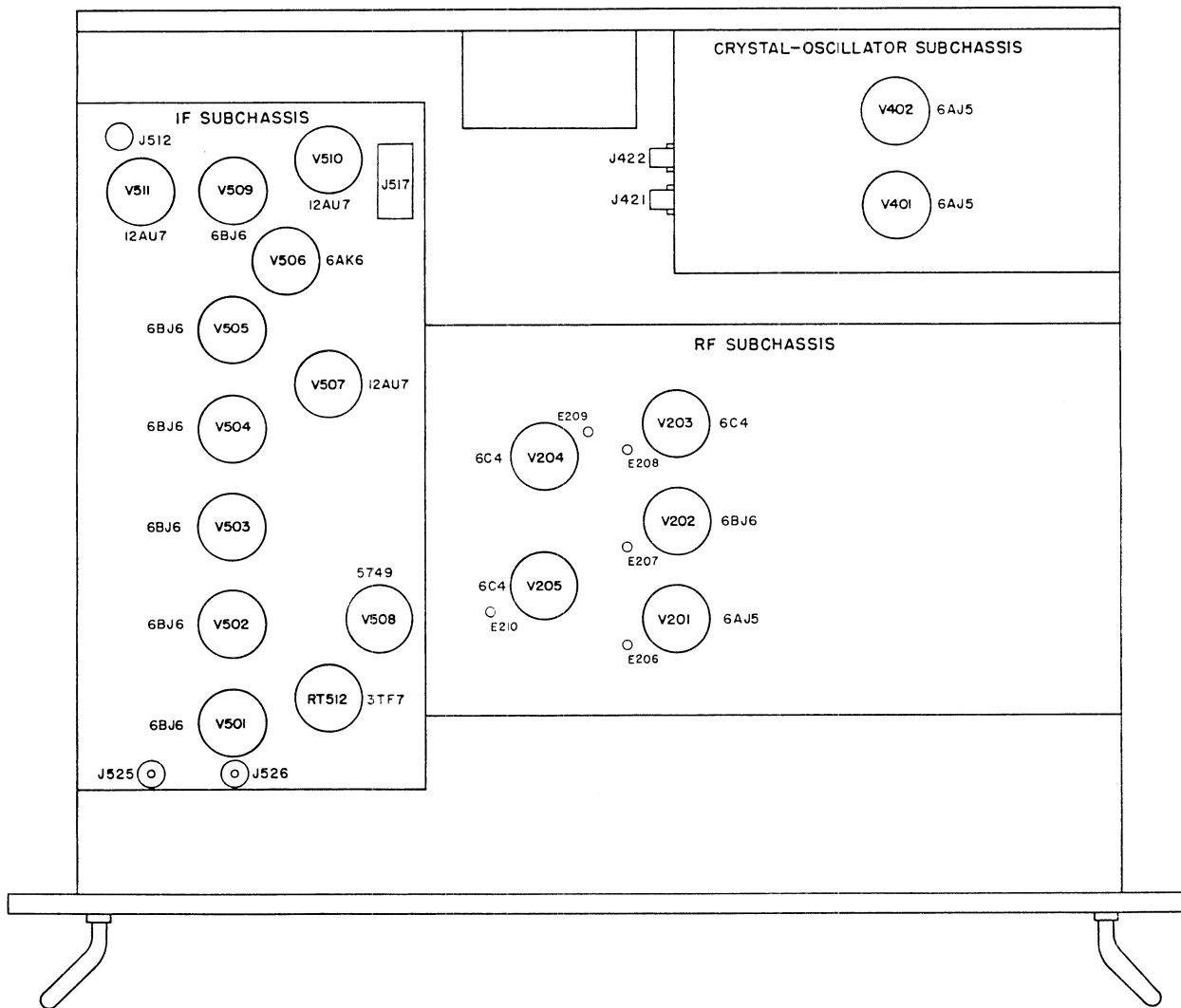

TM5820-357-20-6

Figure 8. Tube locations, top deck.

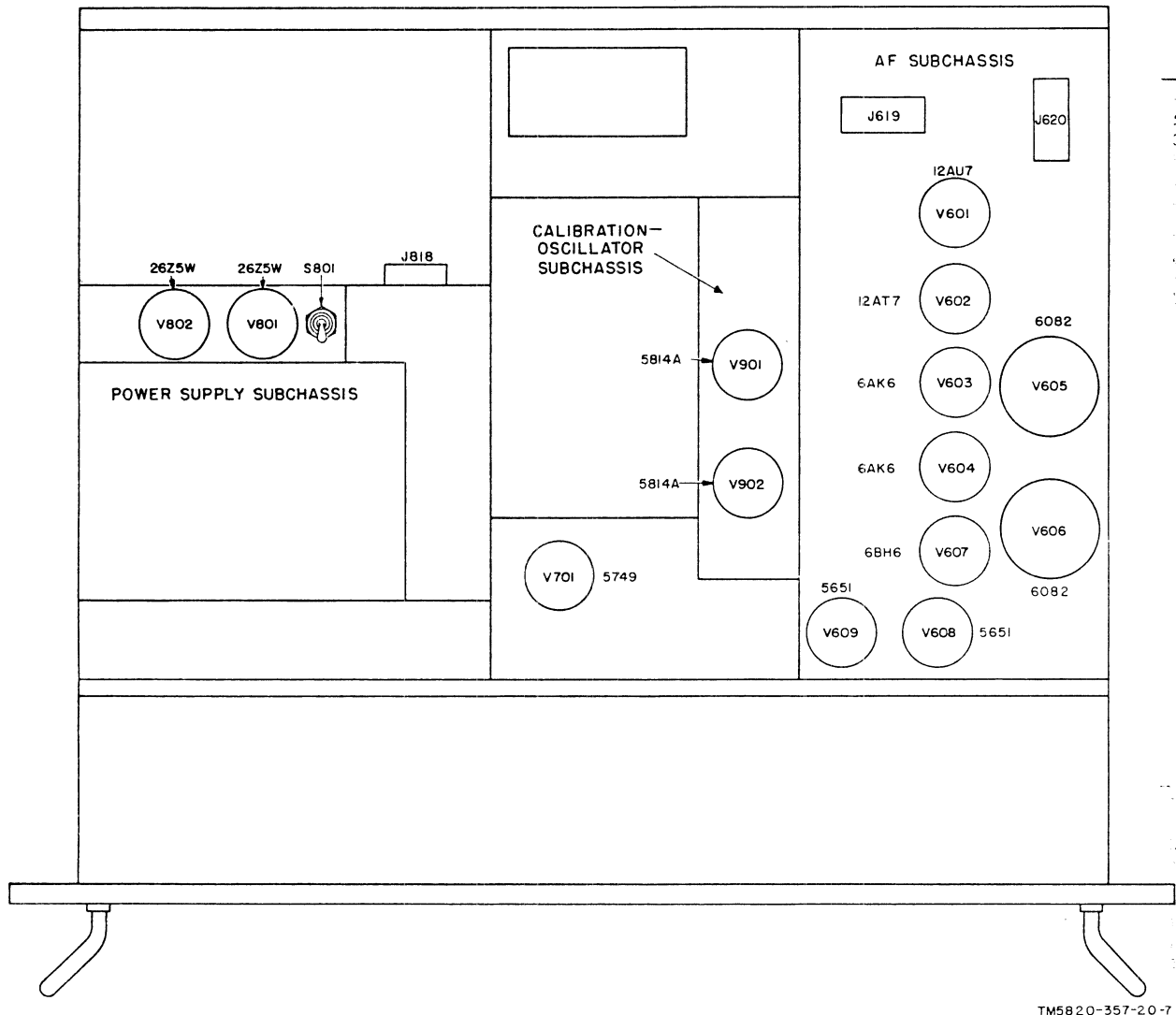

TM5820-357-20-7

Figure 9. Tube locations, bottom deck.

13. Equipment Performance Checklist

a. *General.* The equipment performance checklist is a procedure to systematically check equipment performance. All corrective measures which organizational maintenance personnel can perform are given in the *Corrective measures* column. When using the checklist, start at the beginning and follow each step in order.

If the corrective measures indicated do not fix the equipment, troubleshooting is required by higher echelon. Note on the repair tag how the equipment performed and what corrective measures were taken.

b. *Procedure.* Place the set in operation. Allow the equipment to warm up for at least 5 minutes. Operate the equipment as shown in the checklist below.

c. Checklist.

	Step No.	Item	Action or condition	Normal indications	Corrective measures
P R E P A R A T O R Y	1	FUNCTION switch...	Turn to AGC	Dial lamp lights	Check fuses F101 and F102. Check dial lamps. Check power cable.
	2	MEGACYCLE CHANGE control.	Set to each band, in turn.	Normal signal output on each band.	Rotate control several times to clean contacts. Determine which band or bands are inoperative then check crystal used on the bands (para 16).
	3	KILOCYCLE CHANGE control.	Tune across a band ...	Signals received, CARRIER LEVEL meter indicates strength of signal.	Higher echelon repair required.
	4	ANT. TRIM control.	Rotate control	Obtain peak indication on CARRIER LEVEL meter for each band.	Check antenna connector.
	5	LOCAL GAIN control.	Rotate control in either direction.	Volume at loudspeaker increases or decreases.	Check V601, V602, and V603.
	6	LINE GAIN control ..	Rotate control in either direction.	Output level to 600-ohm line or headset and LINE LEVEL meter increases or decreases.	If headset level varies and pointer of meter is sticking, tap meter lightly. If local output is satisfactory but line output is weak, higher echelon repair is required.
E Q U I P M E N T P E R F O R M A N C E	7	RF GAIN control....	Rotate control	Audio output and CARRIER LEVEL meter indication increases or decreases.	Check tubes V201 and V202.
	8	FUNCTION switch...	Turn to MGC	With no signal input, noise level should increase and CARRIER LEVEL meter does not indicate.	Check tubes V509, V510, and V511.
			Turn to AGC and tune through several different signals. Turn to CAL, and then operate the KILOCYCLE CHANGE control. Turn to SQUELCH and then operate the KILOCYCLE CHANGE control. Return FUNCTION switch to AGC and RF GAIN control to 10 at completion of this check.	Output volume nearly constant. Deflection on CARRIER LEVEL meter at each 100-kc reading. No reception of noise while tuning between stations.	Reset ANT. TRIM control. Check tubes V901 and V902. If noise is high, turn the RF GAIN control counterclockwise until the squelch circuit is effective enough to reduce the noise. Check V601.
	9	LIMITER control....	Turn clockwise	Noise peaks are reduced in amplitude.	Check tubes V507 and V510.

	Step No.	Item	Action or condition	Normal indications	Corrective measures
E Q U I P M E N T P E R F O R M A N C E	10	BREAK IN switch ...	Turn to ON. Short BRK IN terminal 9 on rear panel to ground momentarily.	LINE LEVEL meter is disabled and break in relay functions to silence receiver. Line audio output circuits from receiver REMOTE CONTROL receptacle are disconnected from receiver output.	Refer to higher echelon.
	11	LINE METER switch	Turn to +10	Line level is 10 vu above LINE METER indication.	Refer to higher echelon.
			Turn to 0	LINE LEVEL METER indicates the line level controlled by the LINE GAIN control.	
			Turn to -10	Line level is 10 vu below LINE LEVEL meter indication.	
			Turn to OFF	LINE LEVEL meter is disconnected. Line audio output is still connected.	
12	BFO OFF-ON control and BFO PITCH control.	Turn the BFO control to ON. Tune in a cw signal and vary the BFO PITCH control.	Tone of signal varies.	Refer to higher echelon.	
13	BANDWIDTH.....	Turn from 16 to .1 KC.	Selectivity becomes sharper. Only low frequency audio tones are heard in the counterclockwise positions.	Refer to higher echelon.	
14	AUDIO RESPONSE switch.	Operate through three positions.	Permits amplification of nearly full af range in WIDE position, middle and low frequencies in MED. position, and 800 cps in SHARP position.	Refer to higher echelon.	
S T O P	15	OVENS OFF-ON switch.	Turn to OFF	Oscillator ovens are turned off.	
	16	FUNCTION switch...	Turn to STAND BY... Turn to OFF.....	Receiver is silent. Filament circuits and oscillator circuits are kept on for immediate reception. Turns off all receiver circuits.	

14. Troubleshooting Techniques

The procedures in a through h below are effective when isolating receiver faults to a specific subchassis. Replace any defective tubes; if this does not remedy

the trouble, higher echelon repair is required.

a. Presetting Receiver.

- (1) Turn the FUNCTION switch to AGC.

- (2) Turn the BANDWIDTH switch to 16 KC.
- (3) Turn the RF GAIN control to 10.
- (4) Turn the LOCAL GAIN control to 6.
- (5) Tune in a local station, or if no station can be heard, listen to the noise produced by the receiver.
- (6) Turn the LINE METER switch to 0.
- (7) Adjust the LINE GAIN control for a midscale LINE LEVEL meter reading.

b. Power-Supply Subchassis Test. If all tubes light but the CARRIER LEVEL meter does not deflect and no sound or hum is heard in the headset or loudspeaker, check V801 and V802 (fig. 8) and fuses F101 and F102 (TM-11-5820-357-10).

c. Af Subchassis Test. (fig. 8). While listening to a station or to noise, ground DIODE LOAD terminal 14 on the rear panel.

- (1) The signal or noise at the local output and the LINE LEVEL meter indication should be greatly reduced.
- (2) If only the local output is reduced, check V602, V603, and the seating of connector P120.
- (3) If only the remote output is reduced (LINE LEVEL meter pointer moves to the left), check V602, V604, and the seating of connector P119.
- (4) Remove tubes V507 and V510 and, with a pointed metallic probe that has an insulated handle, touch tube socket pin 1 of V510. A loud click in the loudspeaker or headset indicates that the power supply and audiofrequency (af) subchassis are functioning. Carefully replace the tubes after the test.

d. If. Subchassis Test. (fig. 8). With the controls set as in *a* above, turn the BANDWIDTH switch from 16 to each lower position and listen to the signal or noise.

- (1) The output should decrease at each position, until it can hardly be heard at the .1 position.

- (2) If there is little or no change as the BANDWIDTH switch is turned, check V501 through V504 and V506 through V509.
- (3) Remove plug P226 (fig. 8) from receptacle J526 and touch the contact of the receptacle with the probe. A loud click from the loudspeaker or headset indicates that the af and if. circuits are functioning. Carefully replace the plug.

e. Rf Subchassis Test. (fig. 8). Set the controls as in above. Start with the megacycle frequency indicator at 00 and turn the MEGACYCLE CHANGE control through its range to the highest frequency and listen to the noise in the headset or loudspeaker.

- (1) Across the tuning range, some adjustment of the ANT. TRIM control is necessary to produce maximum noise.
- (2) The noise at each detent position should be almost constant.
- (3) There should be a pronounced increase in noise as the control is seated in each detent.
- (4) If the rf tuner does not pass this test, check V201 through V204, V207 and V701.

Note. When V701 is replaced, the subchassis must be realigned at higher echelon.

- (5) If all bands except 00 through 08 operate, change crystal Y201.
- (6) Each crystal in crystal oven HR401 operates a megacycle band or a combination of 1-megacycle bands. To determine which crystal is defective, proceed as follows:
 - (a) Turn the MEGACYCLE CHANGE control to each band to determine which bands are inoperative.
 - (b) Record the numbers of the defective bands.
 - (c) Match the combination of defective bands with the combinations listed in the chart below.
 - (d) Replace the defective crystal (fig. 10).

Megacycle band affected	Crystal in use
00, 17	Y401
01, 18	Y402
02, 08, 19, 30	Y403
03, 20	Y404
04, 09, 21	Y405
05, 22	Y406
06, 10, 23	Y407
07, 15, 24	Y408
11, 25	Y409
12, 27	Y410
13, 29	Y411
14, 31	Y412
16	Y413
26	Y414
28	Y415

f. Noise at Grid Test Points. Set Multimeter AN/URM-105 to the highest resistance range. Connect one test lead to the chassis and, in turn, touch the prod on the other lead to grid test points (fig. 8 and 9) E210, E209, E208, E207, and E206 in that order. A click should be heard each time the prod touches the test point.

g. Calibration Oscillator Test. To test the calibration oscillator, proceed as follows:

- (1) Turn the FUNCTION switch to CAL.
- (2) Turn the MEGACYCLE CHANGE control to band 00.
- (3) Tune the KILOCYCLE CHANGE control through its entire range.
- (4) Listen for a beat note at every 100-Kilocycle (Kc) point as the KILOCYCLE CHANGE control is tuned.
- (5) If the calibrator fails to operate, make the following tests in the order indicated:
 - (a) Check V205 and V206 (fig. 8).
 - (b) Replace Y203.
 - (c) If the fault cannot be remedied by this procedure, higher echelon repair is required.

h. Antenna Circuit Test. Rotate the ANT. TRIM control. The CARRIER LEVEL meter should peak at one particular point.

- (1) Disconnect the antenna and ground ANTENNA J107 UNBALANCED WHIP connector (TM 11-5820-357-10). A click should be heard and the noise should drop sharply.

- (2) Ground both contacts of ANTENNA J108 BALANCED 125 OHM connector. A click should be heard and the noise should drop sharply.
- (3) If the receiver does not pass this test, check the connectors on the antenna relay box.

15. Tube-Replacement Techniques

a. Isolate the trouble to a specific sub-chassis of the receiver (para 14).

b. Inspect all interior cable connectors for proper seating before removing a tube.

c. Substitute a new tube for an original one. If no change is apparent in the operation of the receiver, replace the new tube with the original. Check each original tube until the equipment becomes operative or until all suspected tubes have been tested.

- (1) Some circuits, such as oscillator circuits (V206, V207, V401, V505, and V701 (fig. 8 and 9)), may function with one tube and not another, even though both tubes are new.
- (2) If a replacement tube soon becomes defective, higher echelon repair is required.
- (3) If tube substitution does not correct the trouble, *be sure that the original tubes are in the original sockets before forwarding the defective receiver for higher echelon repair.*
- (4) If another receiver of the same type is available, refer to the instructions in *b* below.

d. Discard tubes only in the cases given in (1) and (2) below. Do not discard them merely because they meet or are slightly above the lowest acceptable value listed in the tube tester chart. Do not discard tubes merely because they have been used for some time. Satisfactory operation in the receiver is the final proof of tube quality.

- (1) Discard a tube when a tube tester or other instrument shows the tube to be defective.
- (2) Discard a tube when the defect, such as a broken glass envelope or a broken connecting pin can be seen.

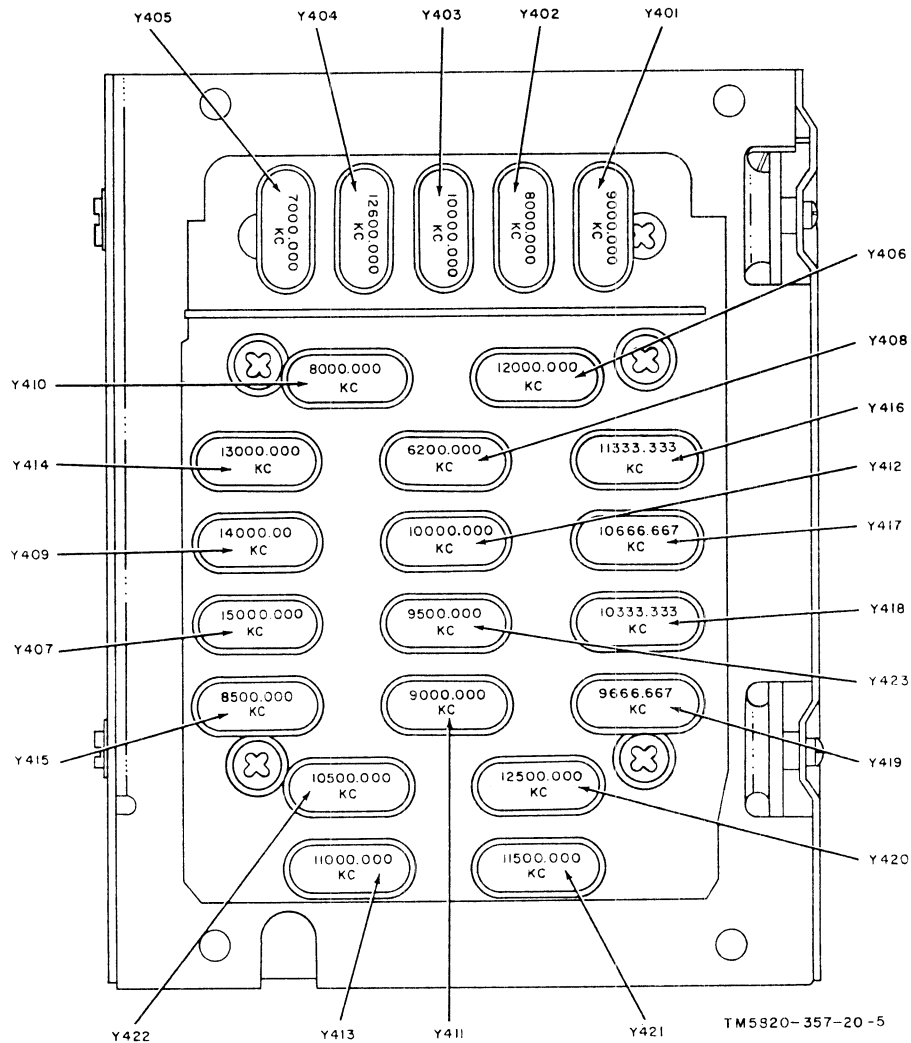

Figure 10. Location of crystals.

e. Be careful when withdrawing a miniature tube from its socket. Do not twist or turn the tube; pull it straight up. The variable-frequency oscillator tube shield is held in place by a special clamp. Be sure that the metal insert is in place, and then replace the shield. Straighten the pins with the proper pin straightener (TM 11-5820-357-10) before replacing tubes in the receiver.

f. Tune a similar receiver, which is in good operating condition, to a voice signal that is not subject to fading; a signal on one of the lower frequency bands is preferred. Turn the FUNCTION switch to AGC and the RF GAIN control to 10. Make the substitutions from the faulty receiver

to a corresponding position in the good receiver, one tube at a time. Tap the tube under test; if noise or abnormal change in volume is observed, replace the tube. A considerable decrease in indication on the CARRIER LEVEL meter, or a noticeable decrease in volume or quality of the signal emitted from the speaker or headset indicates a weak or otherwise defective tube. However, different test results for the following tubes must be observed:

- (1) When automatic gain control (agc) tube V509 or V510 is weak, a decreased indication on the CARRIER LEVEL meter with an increase in volume may be noted. A weak V511 (agc time constant circuit) will

cause an increase in indication on the CARRIER LEVEL meter without any change in volume.

- (2) A weak section of V511 (if cathode follower) will produce a weak signal at J106 IF OUTPUT 50 OHM connector.
- (3) To test tubes V507 and V510 (noise limiters), tune the receiver away from the test signal. If noise is received, rotate the LIMITER control clockwise; the tubes under test and tubes known to be good should be equally effective in reducing noise. After testing these tubes, return the LIMITER control to OFF and retune the receiver to the test signal.
- (4) To test beat frequency oscillator tube V508, turn the BFO OFF-ON switch to ON and, while turning the BFO PITCH control through its entire range, listen for the beat note.
- (5) Inspect tubes V801 and V802 of the power supply to see that all four heaters glow with equal brightness; a blue flash indicates an arcing tube.
- (6) Check V605, V606, and V607 of the audiofrequency subchassis and V701 of the vfo subchassis by listening to the audio output and observing the indication on the CARRIER LEVEL meter. Inspect V608 and V609; if they do not show a lighted filament, they will cause abnormal B+ voltage.
- (7) When testing calibration circuit tubes V901 and V902, turn the FUNCTION switch to CAL, tune through several 100-kc points, and observe the indication on the CARRIER LEVEL meter.
- (8) Test the tubes in the af circuits by listening to the volume and quality of the output signal of the af channels. When testing tubes V601, V602, and V603 (local af amplifier), listen to the output signal of the local audio channel. When testing tube V601, also test the squelch circuit by tuning between stations

to see if it is operating properly; that is, eliminating all interchannel noise and static.

- (9) When testing tubes V602 (line af amplifier) and V604, listen to the output signal from the balanced-line circuit and observe the indication on the LINE LEVEL meter. Generally, small changes in LINE LEVEL meter indication may be expected because of the differences between tubes.

16. Removal and Replacement of Power Supply PP-621/URR

(fig. 9)

a. To remove the power-supply subchassis, proceed as follows:

- (1) Remove the bottom dust cover from the receiver.
- (2) Disconnect large connector plug P118 from jack J818 (fig. 9).
- (3) Loosen the two hidden screws, accessible through holes indicated by arrows marked MTG SCREWS INSIDE.
- (4) Loosen the green captive screw in the corner of the subchassis near tube V802.
- (5) Remove the four green, 7/16-inch screws that secure the power transformer to the side of the main frame.
- (6) Lift the subchassis straight up from the receiver.

b. To replace the power-supply subchassis, proceed as follows:

- (1) Lower the subchassis straight down into the receiver.
- (2) Replace and tighten the green captive screw in the corner of the subchassis near tube V802.
- (3) Replace and tighten the four green, 7/16-inch screws that secure the power transformer to the side of the main frame.
- (4) Replace and tighten the two hidden screws.
- (5) Connect large connector plug P118 to jack J818.
- (6) Replace the bottom dust cover.

Note. Except for installations where extreme dust conditions exist, the bottom and top dust covers will not be used.

17. Removal and Replacement of Pilot Lamps

For location of pilot lamps, refer to TM 11-5820-357-10.

a. Removal.

- (1) Remove the four Phillips screws from the corners of the frequency-indicator window.

- (2) Move the frequency-indicator window a few inches from the front panel. Its connecting wires will hold it in position.
 - (3) Remove the defective pilot lamp.
- ### *b. Replacement.*
- (1) Insert the new pilot lamps.
 - (2) Place the frequency-indicator window in position; line up the four screw holes.
 - (3) Replace and tighten the four Phillips screws.

CHAPTER 4

SHIPMENT AND LIMITED STORAGE

18. Disassembly

The following instructions are recommended as a guide for preparing the receiver for transportation and storage.

- a. Disconnect the antenna lead-in cable.
- b. Disconnect the power cable from the ac outlet, and from the back of the receiver. Neatly coil the power cable and secure with two lengths of pressure-sensitive tape.
- c. Remove all connections to the terminal boards on the rear panel of the receiver.
- d. Unplug the headphone cord from the PHONES jack on the front panel.

e. If dust covers and tube shields were removed from the receiver for ventilation purposes, reinstall them before packing.

19. Repacking for Shipment or Limited Storage

The exact procedure for repacking depends on the material available and the conditions under which the receiver is to be shipped or stored. Follow the procedure in through below whenever possible, as well as the information concerning the original packaging (para 3 and fig. 1).

a. Material Requirements.

Material	Quantity
Fiberboard, corrugated, single-faced.	40 sq ft
Tape, water-resistant, pressure-sensitive, 3-inch.	16 ft
Steel strapping, 5/8-inch by 0.020-inch.	13 ft
Wooden shipping crate, 22-1/4 x 20-1/2 x 14-3/4.	1

b. Packaging.

- (1) Enclose each technical manual in a close-fitting paper envelope. Seal the seams of the envelope with water-resistant, pressure-sensitive tape.
- (2) Cushion the receiver on all surfaces with pads made of single-faced corrugated fiberboard, in order to absorb shocks that might be caused by handling and shipping.
- (3) Securely pack the running spares.

Packing.

- (1) Line the wooden crate with enough material so that it may be sealed

over the receiver when it is placed in the crate.

- (2) Place the packaged receiver, the packaged manuals, and the running spares in the crate.
- (3) Seal the fiberboard carton with the water-resistant, pressure-sensitive tape.
- (4) Nail the top of the wooden crate.
- (5) On intertheater shipments only, apply two bands of steel strapping.
- (6) Mark the shipping crate according to the requirements of AR 220-10.

APPENDIX I

REFERENCES

Following is a list of references applicable and available to the unit repairman of Radio Receiver R-390/URR.

AR 220-10	Preparation for Overseas Movement of Units (POM).
AR 750-5	Maintenance Responsibilities and Ship Operation.
DA Pam 108-1	Index of Army Motion Pictures, Film Strips, Slides, and Phono Recordings.
DA Pam 310-4	Index of Technical Manuals, Technical Bulletins, Supply Bulletins, Lubrication Orders, and Modification Work Orders.
FM 21-5	Military Training.
FM 21-6	Techniques of Military Instruction.
FM 21-30	Military Symbols.
SR 320-5	Dictionary of United States Army Terms.
SR 320-50	Authorized Abbreviations and Brevity Codes.
TM 11-666	Antennas and Radio Propagation.
TM 11-2629	Antenna Kit for Double-Doublet Receiving Antenna (Drawing ES-E-276-F).
TM 11-5820-357-10	Operators Manual, Radio Receiver R-390/URR.
TM 11-6625-203-12	Operation and Organizational Maintenance: Multimeter AN/URM-105, including Multimeter ME-77/U..
TM 11-6625-274-12	Operator's and Organizational Maintenance Manual: Test Sets, Electron Tube TV-7/U, TV-7A/U, TV-7B/U, and TV-7D/U.

By Order of the Secretary of the Army:

G. H. DECKER,
*General, United States Army,
Chief of Staff.*

Official:

R. V. LEE,
*Major General, United States Army,
The Adjutant General.*

Distribution:

Active Army:

To be distributed in accordance with DA Form 12-7 requirements for TM 11 series (Unclas) plus the following:

USASA (2)	11-32
CNGB (1)	11-57
Tech Stf, DA (1) except	11-85
CSigO (18)	11-86
DASA (6)	11-98
ARADCOM (2)	11-117
ARADCOM Rgn (2)	11-155
MDW (1)	11-500 AA-AE (4)
Seventh US Army (2)	11-557
EUSA (2)	11-587
USASCS (Ft Monmouth) (109)	11-592
Units org under fol TOE:	11-597
(2 each UNOINDC)	32-51
11-7	32-56
11-16	32-57

NG: State AG (3) Units same as Active Army except allowance is one copy to each unit.

USAR: None.

For explanation of abbreviations used, see AR 320-50.



